

REVISIONS			
REV.	DESCRIPTION	DATE	APPROVED
A	PRODUCTION RELEASE	11/25/15	K.R.
B	REVISED PER ECO 11448	4/14/16	K.R.
C	REVISED PER ECO 11505	7/14/16	K.R.

Nominal Coil Voltage	Part Number
12 Vdc	R521K-420853
24 Vdc	R521K-480853

REVISIONS	C	C	C	C	C		 <b>DowKey<sup>®</sup> Microwave</b> CORPORATION <small>A DOVER TECHNOLOGIES COMPANY</small>	4822 McGrath Street Ventura, CA. 93003-5641 PH: (805) 650-0260 FAX: (805) 650-1734	
SHEET NO.	1	2	3	4	5				
APPROVALS		DATE					<b>SW, SPDT, LATCHING SELF CUT-OFF SMA-FEMALE CONNECTORS, OPTICAL INDICATORS, 50 OHM [2W] TERMINATIONS, 10 MIL CYCLE, 26.5 GHz</b>		
DRAWN	T. JOHNSON					2/17/15			
ENGINEERING	J. WESSELY					7/14/2016			
QUALITY	S. LYNCH					11/25/2015			
MANUFACTURING	R. GARCIA					11/25/2015			
CODE IDENT. NO.			DWG. NO.						
00471			R521K-4X0853						
SCALE	NONE		FINAL ASSY: 11024-268-V			SHEET 1 OF 5			

# OUTLINE DRAWING:

ACTUATION MARKING

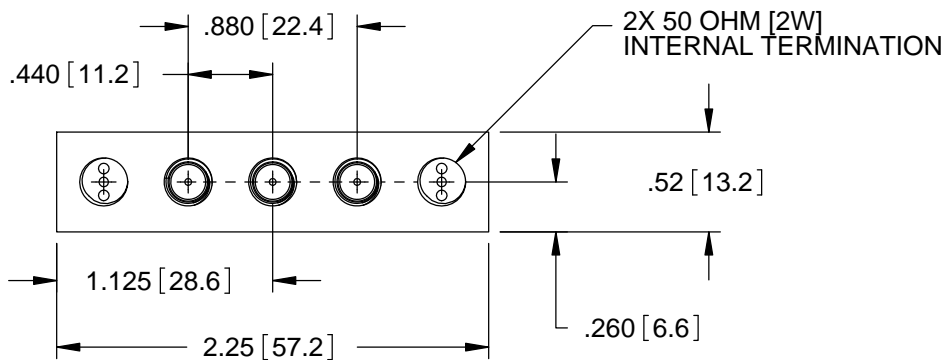
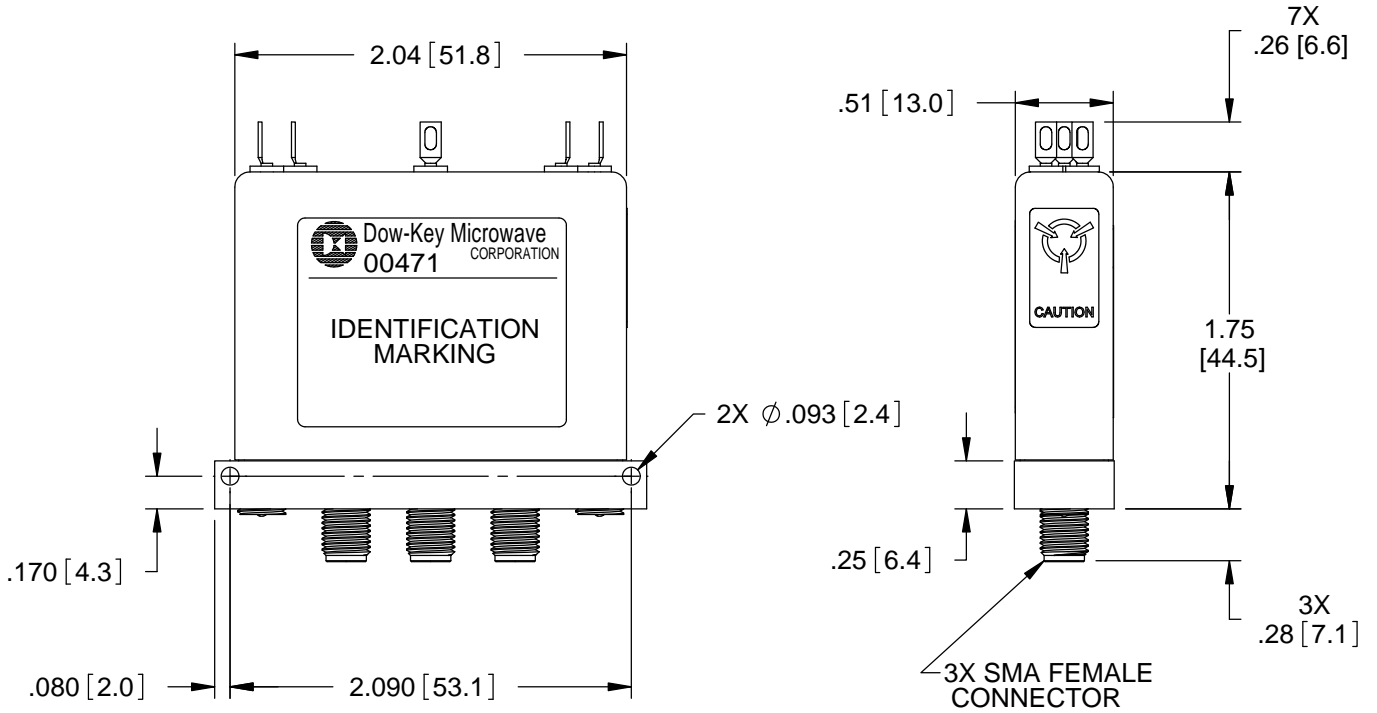
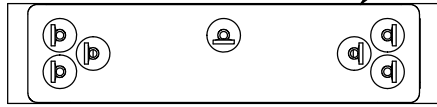

[ ] MILLIMETERS

UNLESS OTHERWISE SPECIFIED TOLERANCES ARE: .XXX ±.010 ANGLES: ±3° .XX ±.030	CODE IDENT. NO. <b>00471</b>	DWG. NO. <b>R521K-4X0853</b>	REV. <b>C</b>
	SCALE NONE	FINAL ASSY: 11024-268-V	SHEET 2 OF 5

# SPECIFICATION:

## 1.0 RF CHARACTERISTICS:

1.1 FREQUENCY (GHz)	DC - 4	4 - 12.4	12.4 - 20	20 - 26.5
1.2 VSWR (RATIO MAX)	1.15:1	1.25:1	1.35:1	1.50:1
1.3 INSERTION LOSS (dB MAX)	0.42	0.56	0.69	0.80
1.3.1 REPEATABILITY (MAX)	0.03 dB @ 25°C (DC - 26.5 GHz)			
1.4 ISOLATION (dB MIN)	85	76	67	60
1.5 HOT SWITCHING (WATTS CW)	2	2	2	2
1.6 IMPEDANCE (NOMINAL)	50 OHMS			

## 2.0 ACTUATION DATA:

2.1	NOMINAL VOLTAGE	OPERATING VOLTAGE	CURRENT (TYP) @ NOMINAL VOLTAGE & 25°C
	12	11-14	120mA
	24	20-32	80mA

2.2 SWITCHING TIME	15mS MAX
2.3 OPERATING MODE	LATCHING SELF CUT-OFF

## 3.0 MECHANICAL:

3.1 CONTACT ARRANGEMENT	SPDT
3.2 RF CONTACTS	BREAK BEFORE MAKE
3.3 WEIGHT	2.5 oz (71 g) NOMINAL
3.4 DESIGN LIFE *	10,000,000 CYCLES MINIMUM

## 4.0 ENVIRONMENTAL:

4.1 OPERATING TEMPERATURE	-25°C TO +75°C
4.2 STORAGE TEMPERATURE	-55°C TO +85°C
4.3 TEMPERATURE CYCLING	-55°C TO +85°C (10 CYCLES PER MIL-STD-202, METHOD 107G, COND A)
4.4 VIBRATION	
4.4.1 SINUSOIDAL OPERATING	7 g, 5-2000 Hz
4.4.2 SINUSOIDAL SURVIVAL	20 g, 20-2000 Hz
4.4.3 RANDOM (OPERATING)	2.41 g (rms), 10 min/AXIS
4.5 SHOCK	
4.5.1 SURVIVAL	HALF SINE: 500 g at 0.5 mS
4.5.2 OPERATING	50 g at 6mS
4.6 HUMIDITY (OPERATING)	15 TO 95% RELATIVE HUMIDITY (NON-CONDENSING)
4.7 ALTITUDE	
4.7.1 OPERATING	15,000 FEET
4.7.2 SURVIVAL	50,000 FEET

\* NOMINAL VOLTAGE = 24V

DESIGN LIFE IS 10 MILLION CYCLES MINIMUM, WHEN DRIVEN AT VOLTAGES  $20 \leq V_{supply} \leq 28$  VDC

DESIGN LIFE IS 2 MILLION CYCLES MINIMUM, WHEN DRIVEN AT VOLTAGES  $28 < V_{supply} \leq 32$  VDC

\* NOMINAL VOLTAGE = 12V

NO DERATING WHEN SWITCH IS OPERATED WITHIN SPECIFIED VOLTAGE RANGE

CODE IDENT. NO. <b>00471</b>	DWG. NO. <b>R521K-4X0853</b>	REV. <b>C</b>
SCALE NONE	FINAL ASSY: 11024-268-V	SHEET 3 OF 5

# SCHEMATIC:

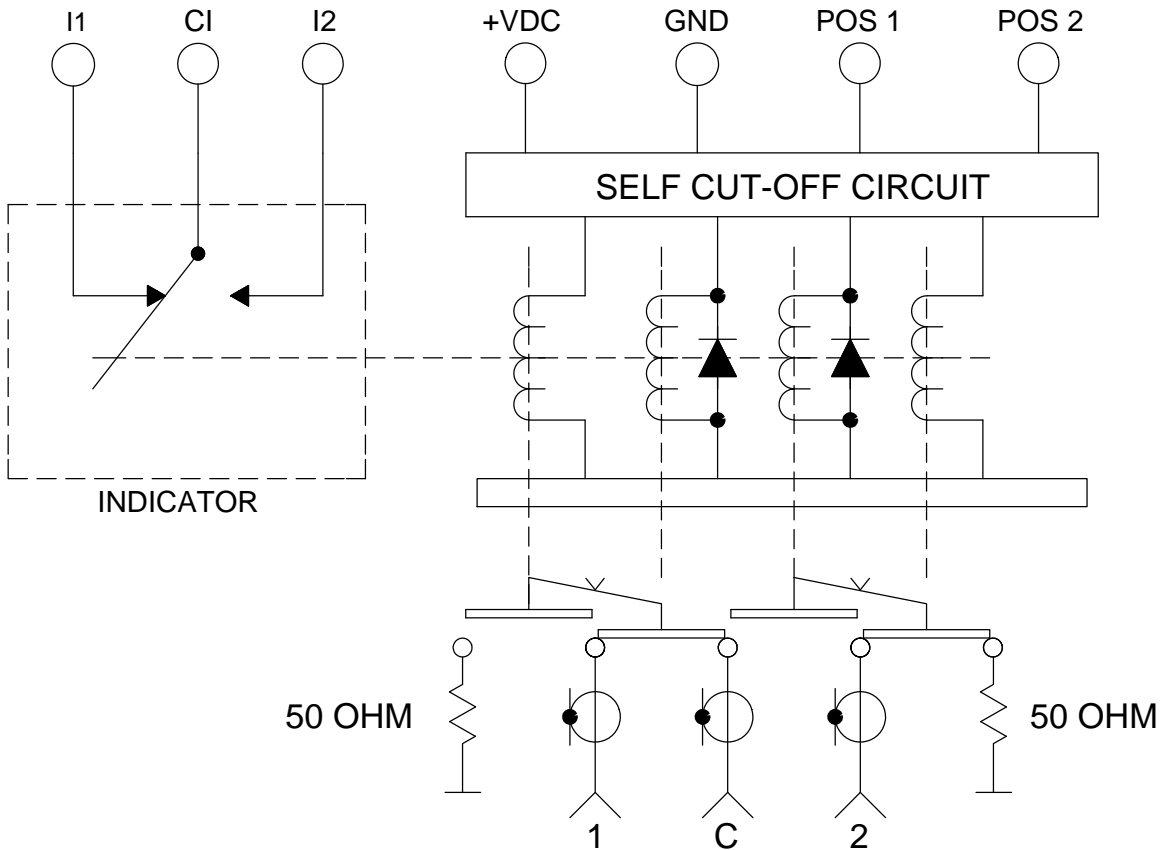

SWITCH SHOWN IN POSITION 1

## **OPERATION:**

- CONNECT GROUND TO -COM, PIN 3
- CONNECT SUPPLY VOLTAGE (+Vdc) TO PIN 4
- SELECT (CLOSE) THE DESIRED RF PATH BY APPLYING GROUND TO THE CORRESPONDING POSITION

NOTE: GROUND CANNOT BE APPLIED TO BOTH POSITIONS SIMULTANEOUSLY

CODE IDENT. NO. <b>00471</b>	DWG. NO. <b>R521K-4X0853</b>	REV. <b>C</b>
SCALE NONE	FINAL ASSY: 11024-268-V	SHEET 4 OF 5

**IDENTIFICATION MARKING:**

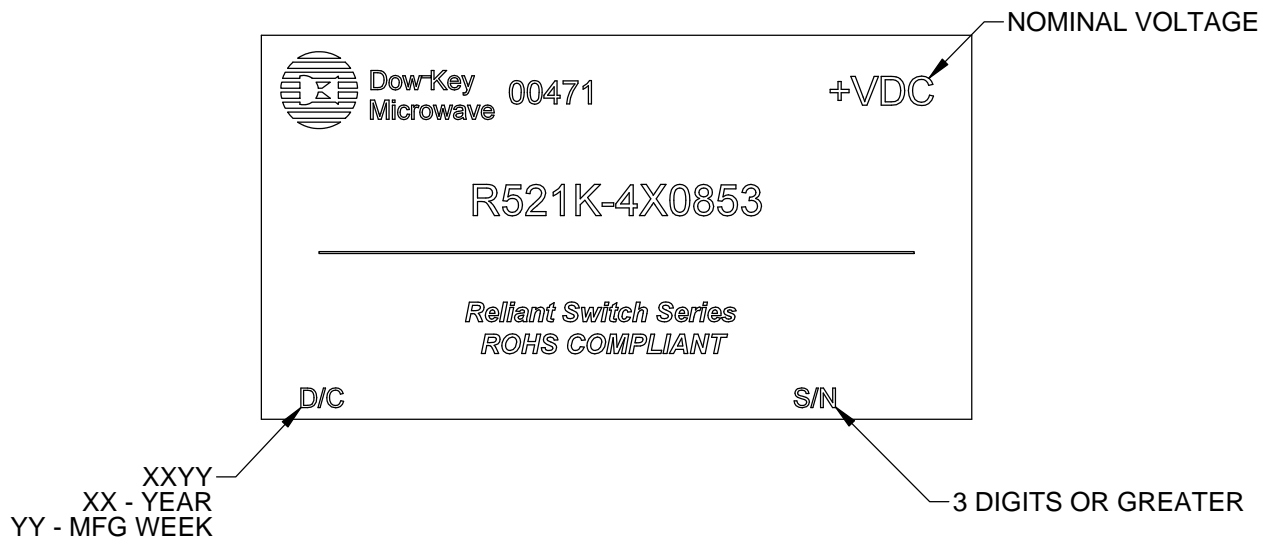

**ACTUATION MARKING:**

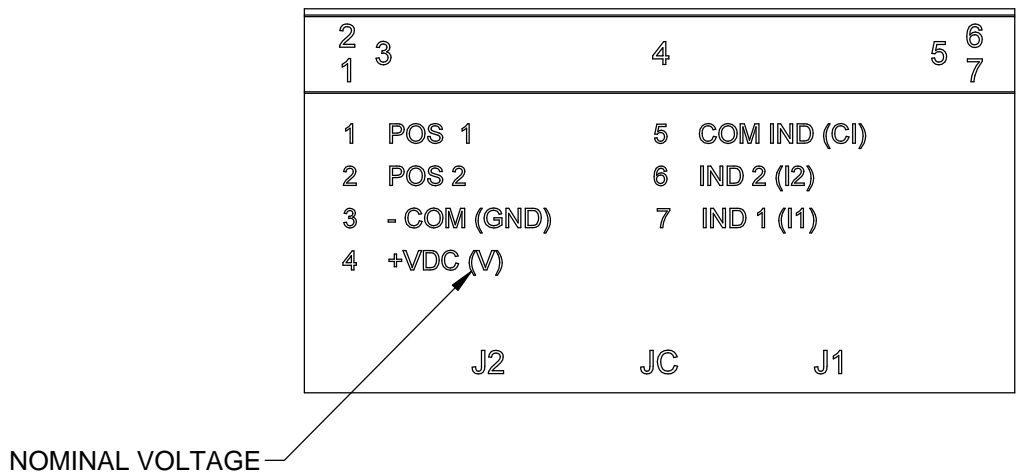

NOTE: ALL WORDS, LETTERS, NUMBERS AND SYMBOLS SHALL BE LOCATED APPROXIMATELY AS SHOWN

CODE IDENT. NO. <b>00471</b>	DWG. NO. <b>R521K-4X0853</b>	REV. <b>C</b>
SCALE NONE	FINAL ASSY: 11024-268-V	SHEET 5 OF 5