



REVISIONS			
REV.	DESCRIPTION	DATE	APPROVED
A	PRODUCTION RELEASE	4/18/07	K.R.

Nominal Coil Voltage	Part Number		
	SP3T	SP4T	SP6T
12 Vdc	531Y-4211	541Y-4211	561Y-4211
24 Vdc	531Y-4811	541Y-4811	561Y-4811
28 Vdc	531Y-4311	541Y-4311	561Y-4311

REVISIONS	A	A	A				 DowKey[®] Microwave CORPORATION	4822 McGrath Street Ventura, CA. 93003-5641 PH: (805) 650-0260 FAX: (805) 650-1734
SHEET NO.	1	2	3					
APPROVALS			DATE			 SWITCH, 3-6 POSITION, LATCHING SELF CUT-OFF 2.9mm (K) FEMALE CONNECTORS, FREQ: 40 GHZ		
DRAWN	SARA LEE		4/17/07					
ENG	G. NICKLAUS		4/17/07					
ENG. MGR.	R. SZNUK		4/17/07					
SALES MGR.	A. CHEUNG		4/17/07					
Q.A. MGR.	R. MATSUMOTO		4/18/07			CODE IDENT. NO.	DWG. NO.	
MFG. MGR.	S. ORNELAS		4/18/07			00471	5X1Y-4X11	
SCALE			NONE			FINAL ASSY:		SHEET 1 OF 3

OUTLINE DRAWING:

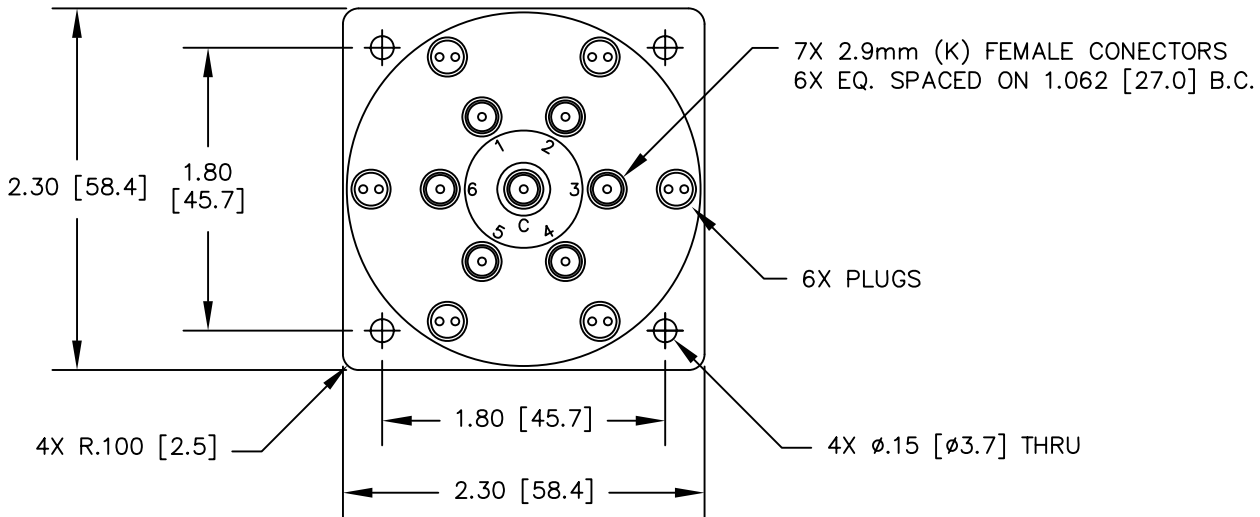
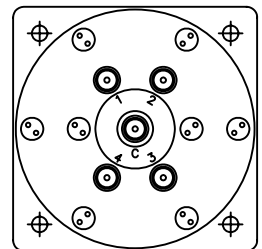
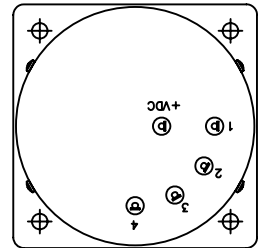
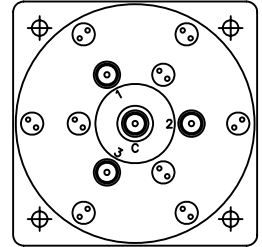
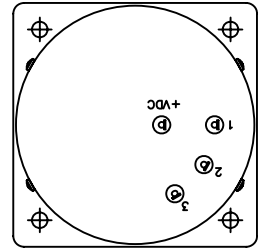
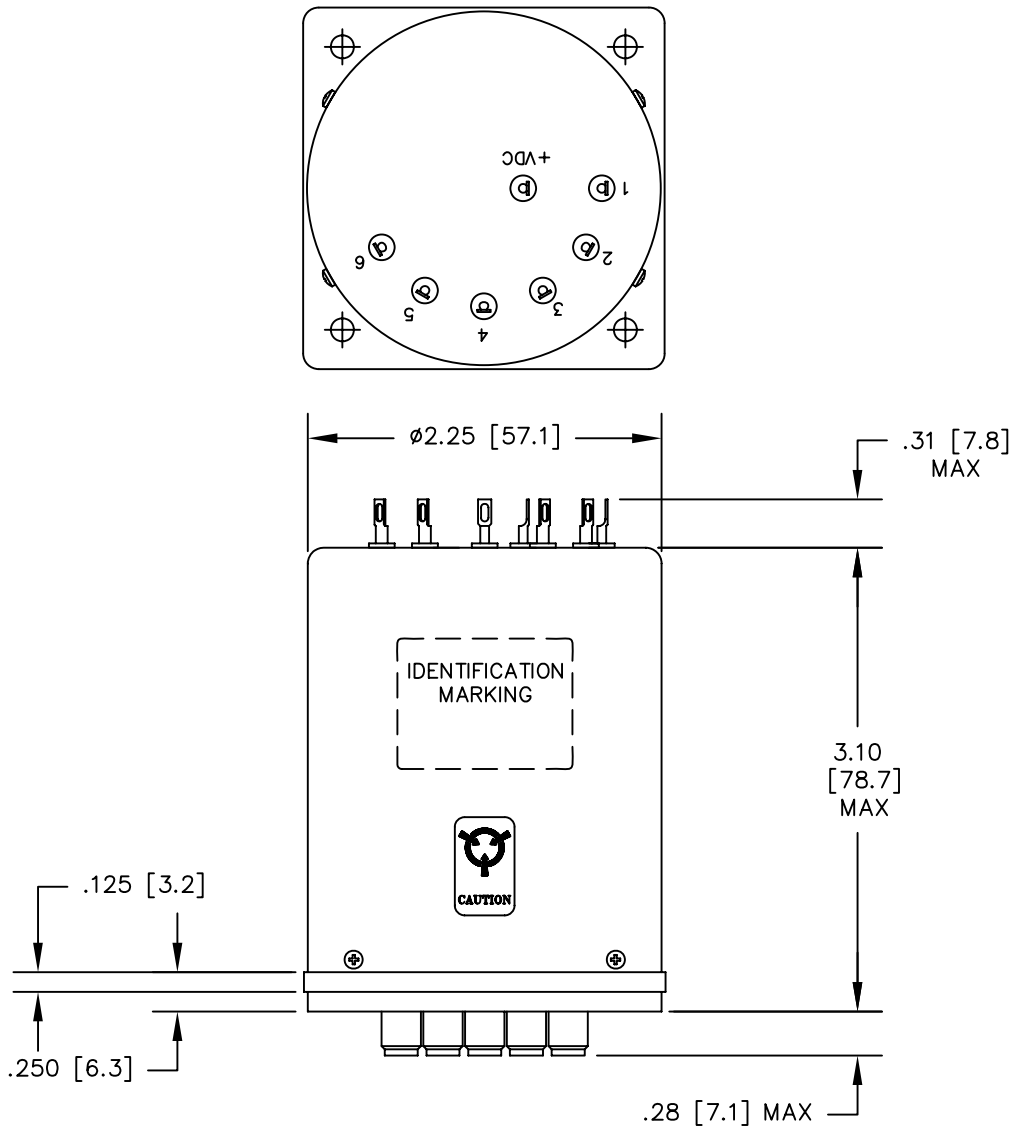

[] MILLIMETERS

UNLESS OTHERWISE SPECIFIED TOLERANCES ARE:
.XXX $\pm .010$ ANGLES: $\pm 3^\circ$
.XX $\pm .030$

CODE IDENT. NO.
00471

DWG. NO.
5X1Y-4X11

REV.
A

SCALE NONE

SHEET 2 OF 3

SPECIFICATIONS:

1. RF CHARACTERISTICS:

1.1 FREQUENCY (GHz):	DC-6	6-12	12-18	18-26.5	26.5-40
1.2 VSWR (RATIO MAX):	1.30:1	1.40:1	1.50:1	1.70:1	1.95:1
1.3 INSERTION LOSS (dB MAX):	0.30	0.40	0.50	0.70	0.95
1.4 ISOLATION (dB MIN):	70	60	60	55	50
1.5 RF POWER (WATTS CW MAX):	100	70	60	45	30

2. ACTUATION DATA:

2.1	NOMINAL VOLTAGE	OPERATING VOLTAGE	CURRENT (TYP) @ NOMINAL VOLTAGE & 25°C
	12	11-14	530mA
	15	13-17	400mA
	24	20-28	240mA
	28	24-32	210mA

- 2.2 SWITCHING TIME: 15ms MAX
 2.3 OPERATING MODE: LATCHING SELF CUT-OFF

3. MECHANICAL:

- 3.1 RF CONTACTS: BREAK BEFORE MAKE
 3.2 WEIGHT: 11oz. (312g.) NOMINAL
 3.3 DESIGN LIFE: 1,000,000 CYCLES MIN

4. ENVIRONMENTAL:

- 4.1 OPERATING TEMPERATURE: -25°C TO +65°C
 4.2 STORAGE TEMPERATURE: -55°C TO +85°C
 4.3 SEAL: SAND AND DUST

SCHEMATIC:

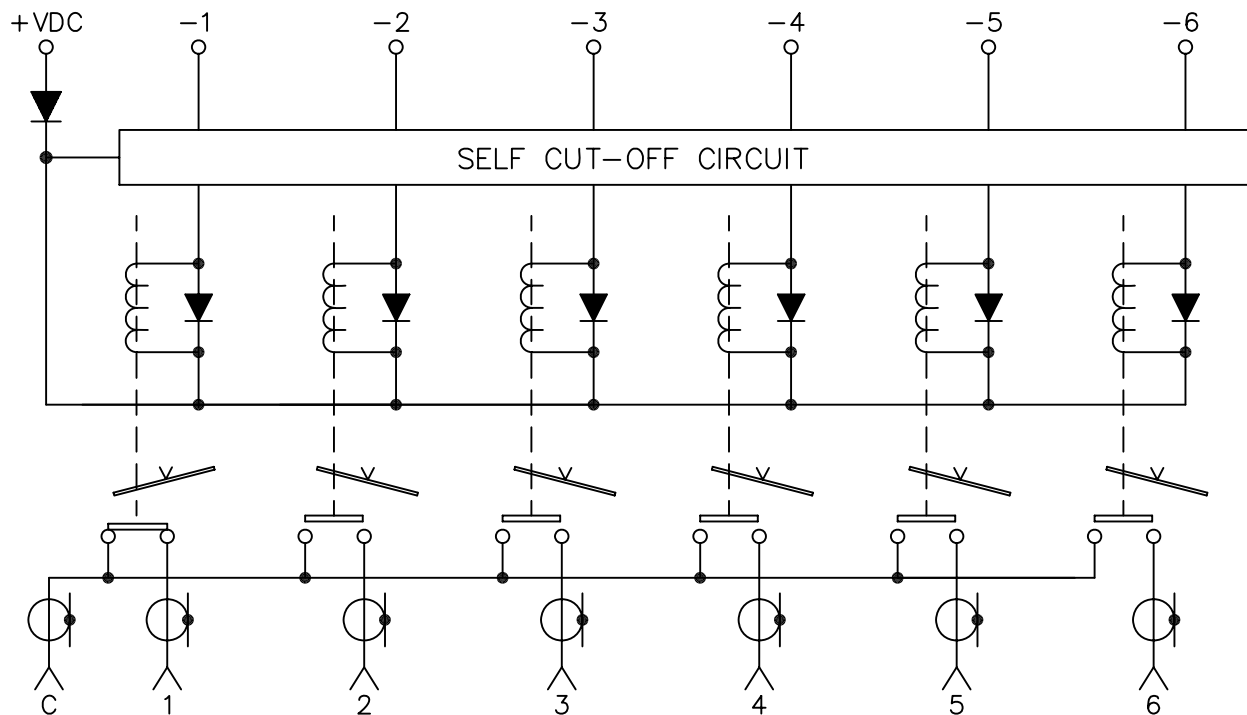

SCHEMATIC SHOWN WITH IN POSITION 1

CODE IDENT. NO. 00471	DWG. NO. 5X1Y-4X11	REV. A
SCALE NONE	SHEET 3 OF 3	